

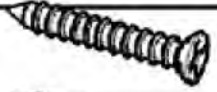









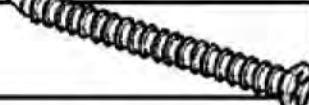





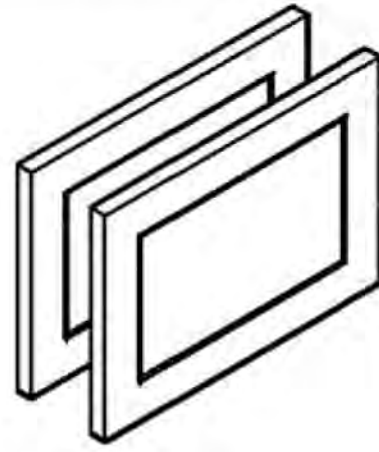

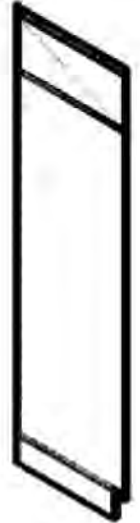
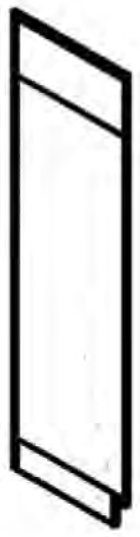
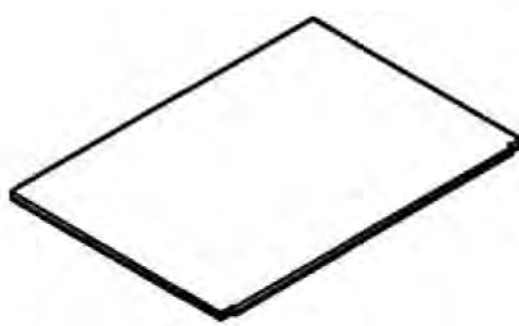

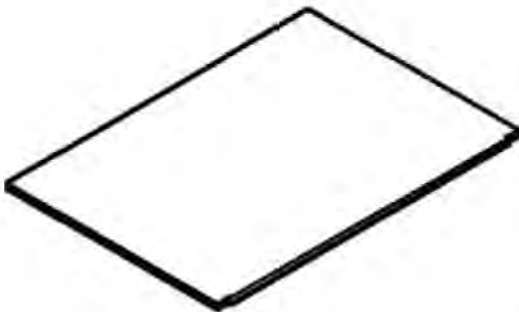
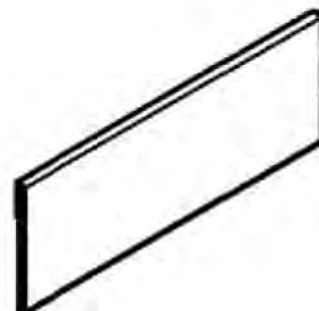

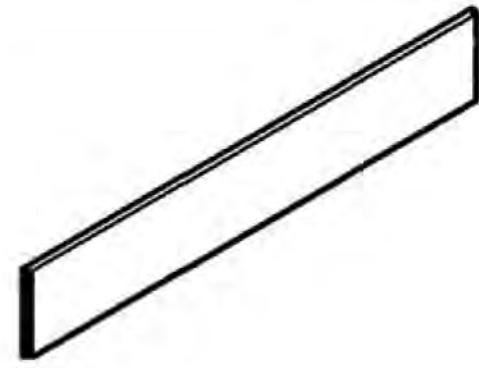
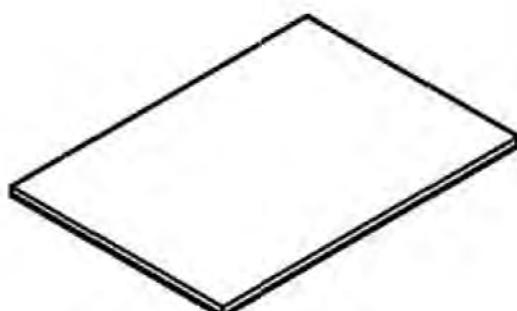
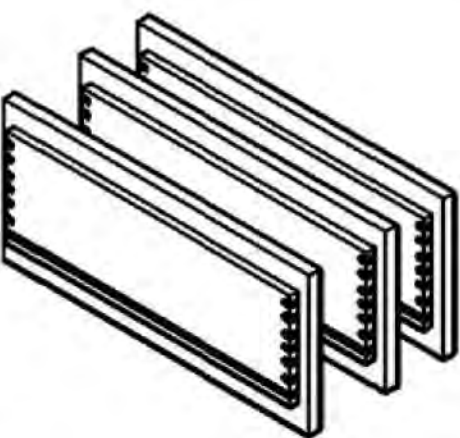
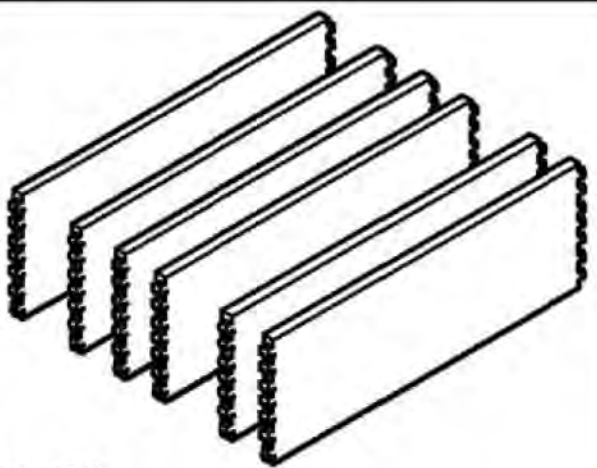
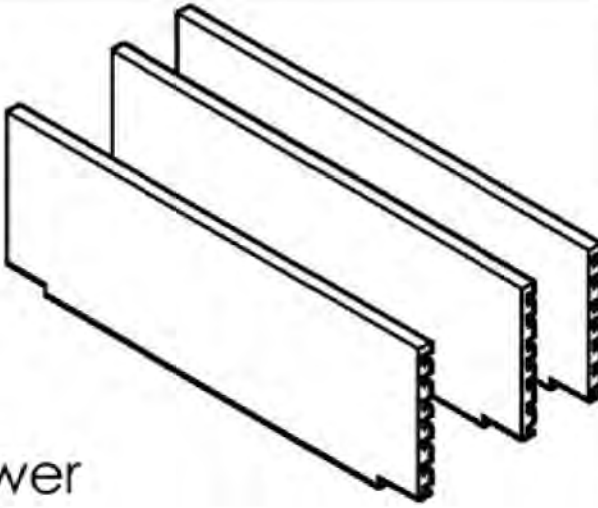
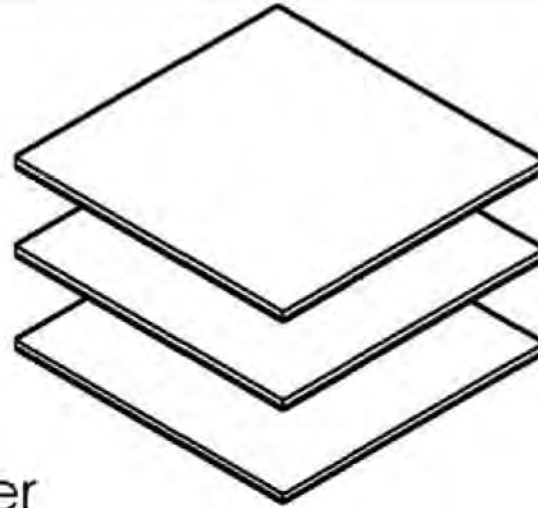



# Oven Cabinet Assembly

No	Picture	Specification
A		Screw $\text{Ø}3 \times 1/2''$
B		Screw $\text{Ø}3 \times 5/8''$
C		Screw $\text{Ø}4 \times 5/8''$
D		Screw $\text{Ø}4 \times 1 \frac{3}{16}''$
E		Hinges
F		L Bracket
G		Drawer Glides
H		Glide Connector
I		Metal Clip
J		Bumper

1  Door	2  Face Frame	3  Left Side Panel
4  Right Side Panel	5  Top Panel	6  Middle Bottom Panel
7  Bottom Panel	8  Top Back Panel	9  Bottom Back Panel
10  Front Toe kick	11  Shelf	
12  Drawer Frame	13  Drawer Sides	14  Drawer Back
	15  Drawer Bottom	

# Oven Cabinet Assembly

NO.	PICTURE	SIZE
A		Screws $\text{Ø}3 \times 1/2''$
B		Screws $\text{Ø}4 \times 1''$
C		L Bracket
D		Drawer Glides
E		Glide Connector
F		Metal Clip

NO.	PICTURE	SIZE
G		Hinges
H		Screws $\text{Ø}4 \times 3/4''$
I		Screws $\text{Ø}4 \times 5/8''$
J		Cleat 21 1/8''
K		Cleat 31 5/16''

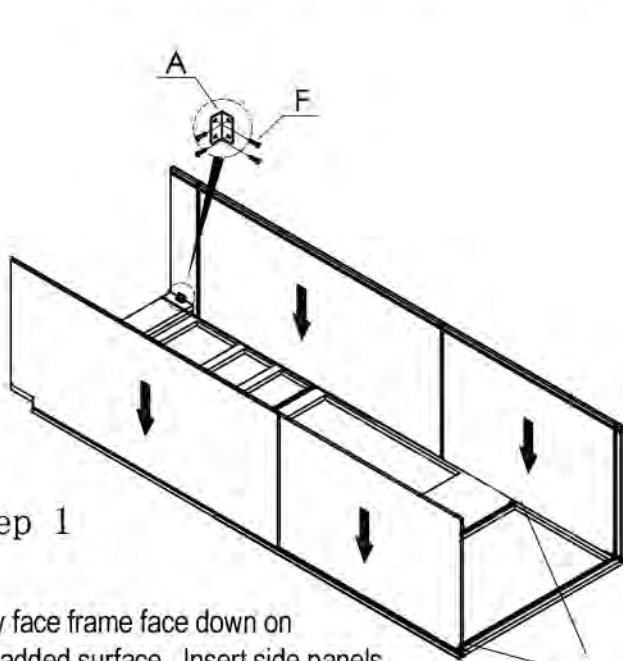

step 1

Lay face frame face down on a padded surface. Insert side panels into dado grooves on back of face frame. Use glue and metal L-Brackets.

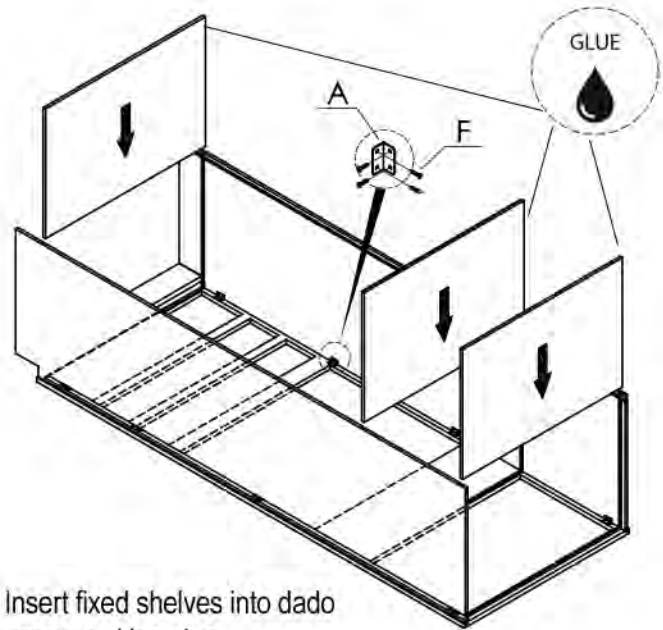

step 2

Insert fixed shelves into dado grooves. Use glue.

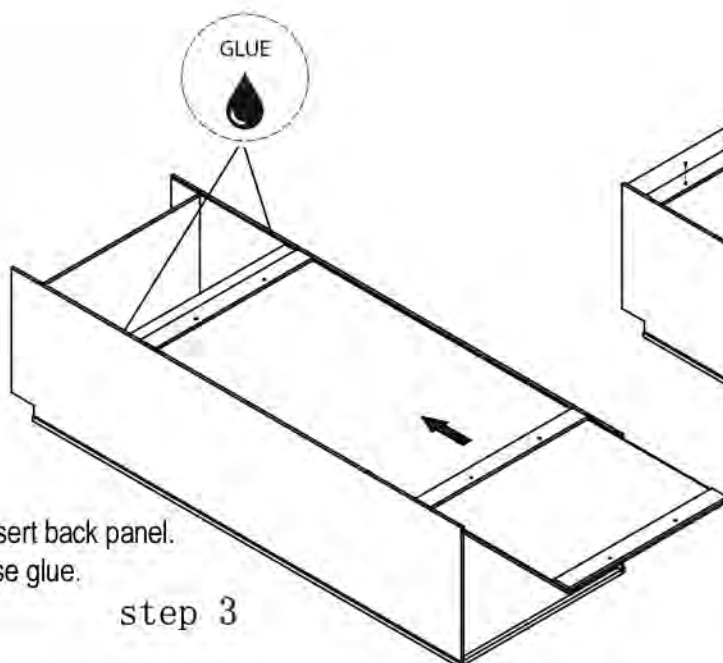

Insert back panel. Use glue.

step 3

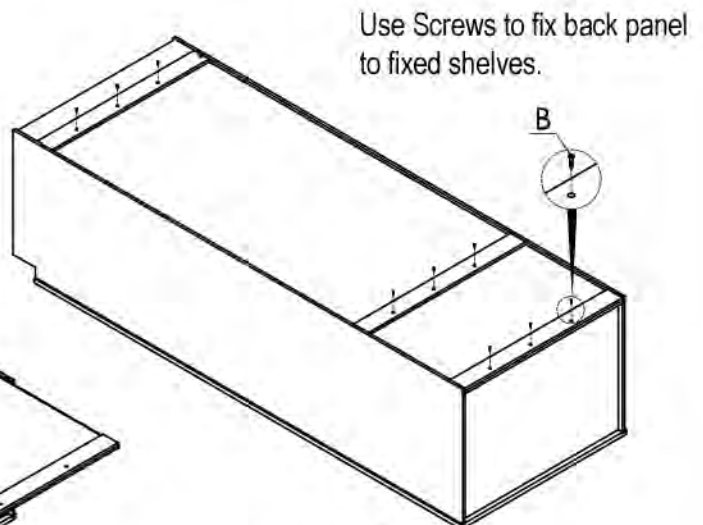

Use Screws to fix back panel to fixed shelves.

step 4

refer to assembly video for more detail



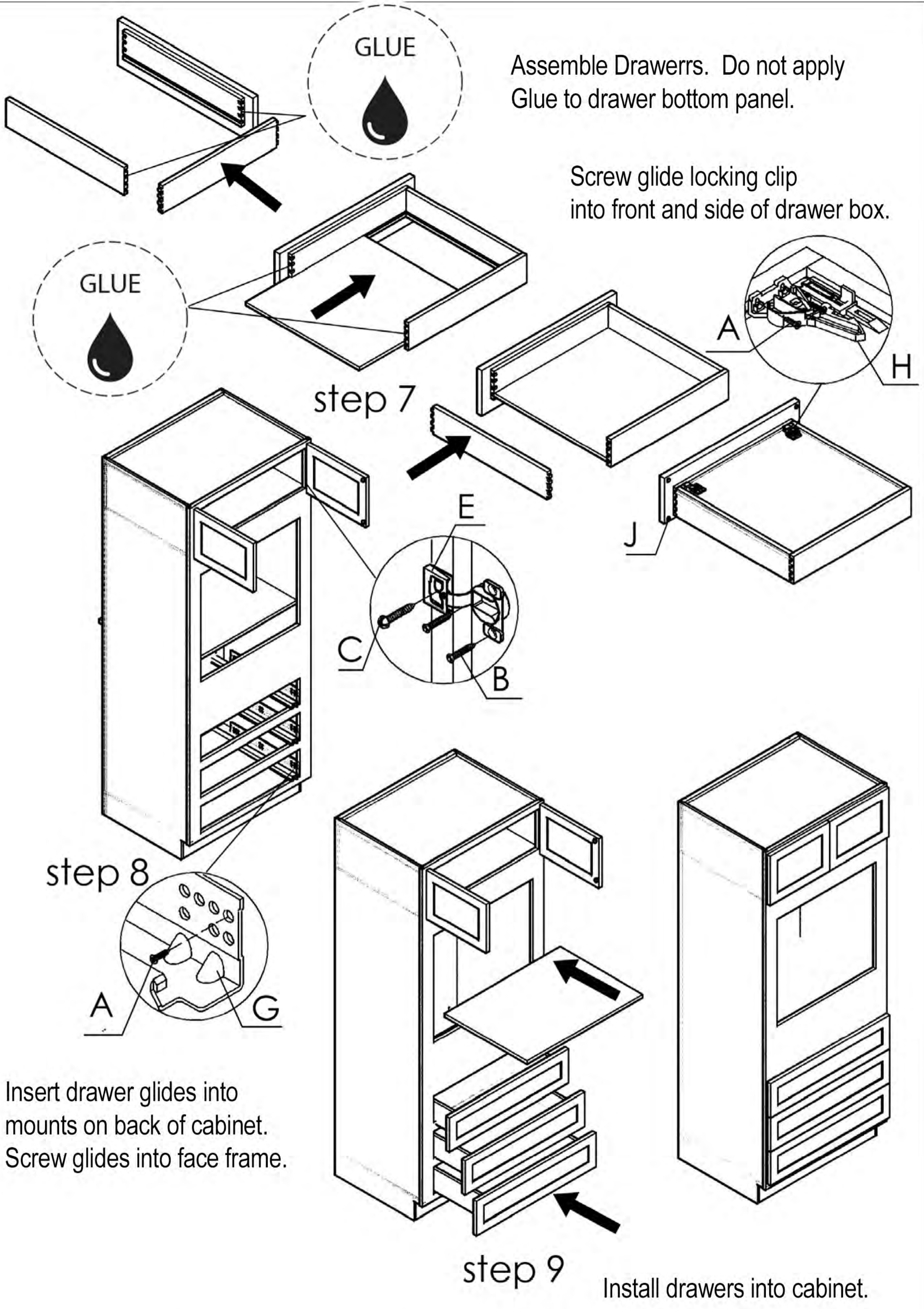

Assemble Drawers. Do not apply Glue to drawer bottom panel.

Screw glide locking clip into front and side of drawer box.

step 7

step 8

step 9

Insert drawer glides into mounts on back of cabinet. Screw glides into face frame.

Install drawers into cabinet.

Refer to assembly videos for more detailed assembly guide